

AC Axial IGE Series

SIZE/尺寸：180X60mm

General Specifications (一般規格)

Motor : Shaded pole AC motor	馬達：交流蔽極式內轉子馬達
Frame : Aluminum die casting	材料：框：鋁
Impeller : Plastic(94V-0)	材料：葉：塑料 (94V-0)
Bearing : Ball bearing	軸承：滾珠軸承
Weight : 1600g	重量：1600克



Major Characteristic Parameters 主要參數

Model	Bearing	Voltage	Freq.	Watt	Speed	Max Air Flow		Max Static Pressure		Sound
機型	軸承	電壓	頻率	功率	轉速	最大風量		最大風壓		噪音
Part NO.	B / F / S	V	Hz	W	RPM	m3/min	CFM	mm-H2O	In-H2O	dBA
IGE18060B1M	B	110/125	50/60	50/45	2650/2800	7.93/8.49	280/300	13.4/13.6	0.53/0.54	62/65
IGE18060B2M	B	200/240	50/60	50/45	2650/2750	7.93/8.49	280/300	13.4/13.6	0.53/0.54	62/65
IGE18060B3M	B	380/420	50/60	50/45	2650/2750	7.93/8.49	280/300	13.4/13.6	0.53/0.54	62/65

Drawing & panel out-cuts 圖面及出入風口

Characteristic Curves 特性曲線

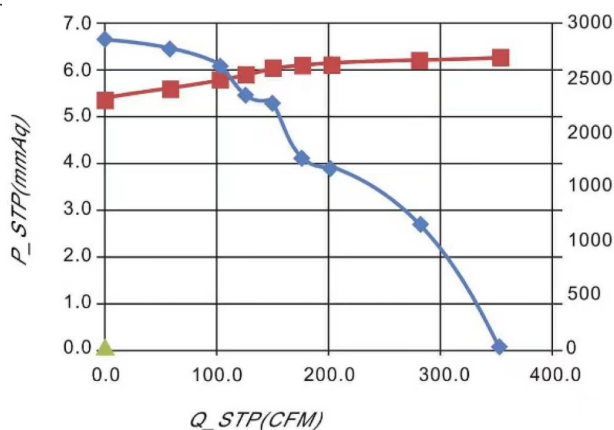
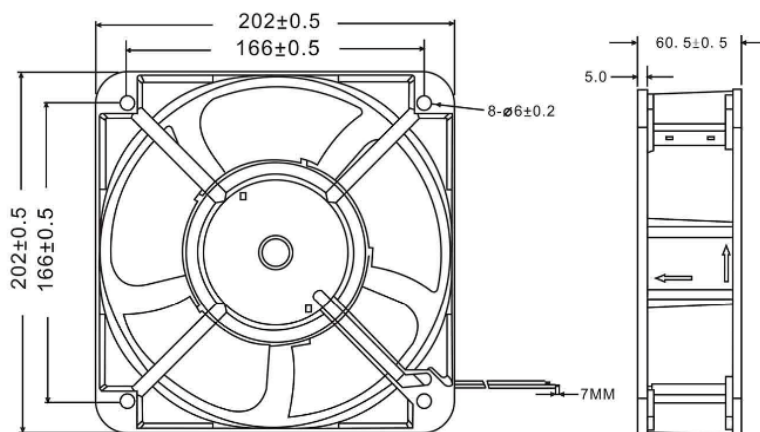

Specification is subject to change for improvement without notice/ 基於改良的規格變更，不另行通知

<http://www.crownelectronics.ltd>

