

# AC Axial IGE Series

SIZE/尺寸：220X60mm

## General Specifications (一般規格)

Motor : Shaded pole AC motor	馬達：交流蔽極式內轉子馬達
Frame : Aluminum die casting	材料：框：鋁
Impeller : Plastic(94V-0)	材料：葉：塑料 (94V-0)
Bearing : Ball bearing	軸承：滾珠軸承
Weight : 1480g	重量：1480克



## Major Characteristic Parameters 主要參數

Model	Bearing	Voltage	Freq.	Watt	Speed	Max Air Flow		Max Static Pressure		Sound
機型	軸承	電壓	頻率	功率	轉速	最大風量		最大風壓		噪音
Part NO.	B / F / S	V	Hz	W	RPM	m3/min	CFM	mm-H2O	In-H2O	dBA
IGE22060B1M	B	110/125	50/60	52/48	2650/2750	9.91/10.76	350/380	12.8/13.1	0.50/0.52	62/68
IGE22060B2M	B	200/240	50/60	52/48	2650/2750	9.91/10.76	350/380	12.8/13.1	0.50/0.52	62/68
IGE22060B3M	B	380/420	50/60	52/48	2650/2750	9.91/10.76	350/380	12.8/13.1	0.50/0.52	62/68

## Drawing & panel out-cuts 圖面及出入風口

## Characteristic Curves 特性曲線

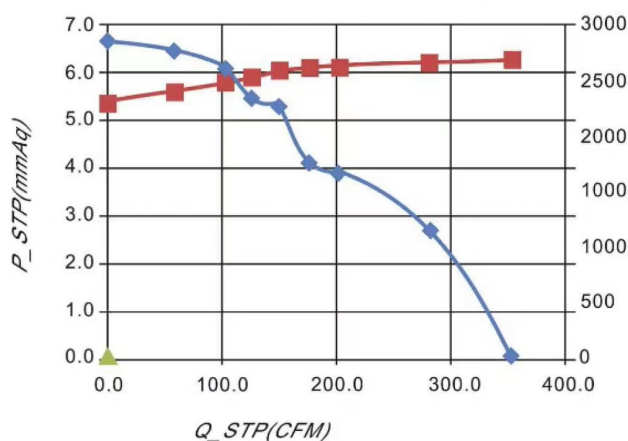
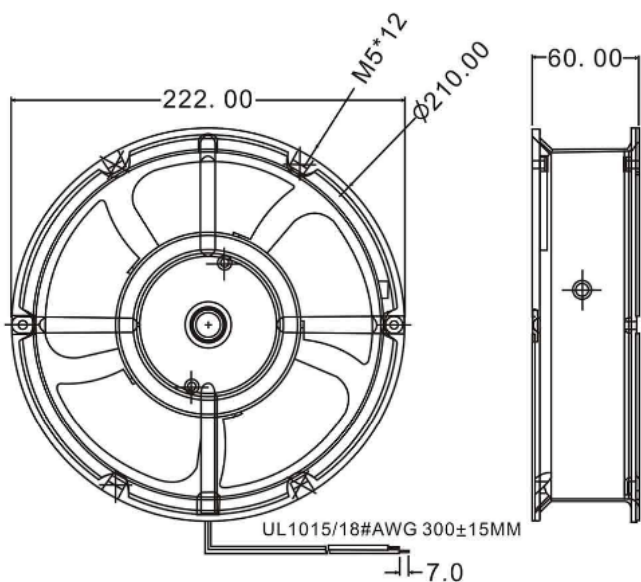

Specification is subject to change for improvement without notice/ 基於改良的規格變更，不另行通知

<http://www.crownelectronics.ltd>

